

### Features

- 120 airjets release thousands of heated bubbles that surround and support the body in a warm massage.
- Automatic and manual purge cycles remove residual water from air channels after use.
- Variable-speed blower lets you adjust massage intensity to 18 levels.
- Comfort Depth® design offers a convenient 19" step-over height while retaining the same depth as a standard 21" bath.
- Integral lumbar support.
- Slotted overflow allows for deep soaking.
- Integral apron.
- Integral flange helps prevent water from seeping behind wall and simplifies alcove installation.
- Textured bottom surface.
- Coordinates with other products in the Archer collection.
- Built-in 600W BubbleMassage™ heater warms humidified air before it enters the bath.
- Automatic and manual purge cycles remove residual water from air channels after use.

### Material

- Acrylic.

### Technology

- Auto-shutoff timer on blower allows users to enjoy Heated BubbleMassage™ experience for 60 minutes before turning off.
- User interface: electronic keypad control.

### Installation

- Right drain.

### Required Products/Accessories

K-7271 Brass Slotted Overflow Bath Drain

or

K-7272 PVC Slotted Overflow Bath Drain

### Recommended Products/Accessories

K-1446 Remote Installation Kit  
K-24916 Wireless Music Kit  
K-23726 Drain treatment  
K-23732 Tub & shower cleaner



ADA

### Codes/Standards







ASME A112.19.7/CSA B45.10  
CSA B45.5/IAPMO Z124  
ASTM E162  
ASTM E662  
UL 1795  
CSA C22.2 No. 218.2  
ADA  
ICC/ANSI A117.1

**KOHLER® Hydrotherapy  
Components Five-Year Limited  
Warranty KOHLER® Plastic Baths  
and Receptors Lifetime Limited  
Warranty**

See website for detailed warranty information.

### Available Colors/Finishes

*Color tiles intended for reference only.*

Color	Code	Description
	0	White
	96	Biscuit
	NY	Dune
	95	Ice™ Grey
	58	Thunder™ Grey
	7	Black Black™

No change in measurements if connected with drain illustrated. (K-7272)

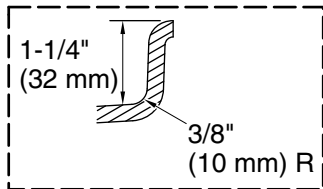

Integral Flange Detail

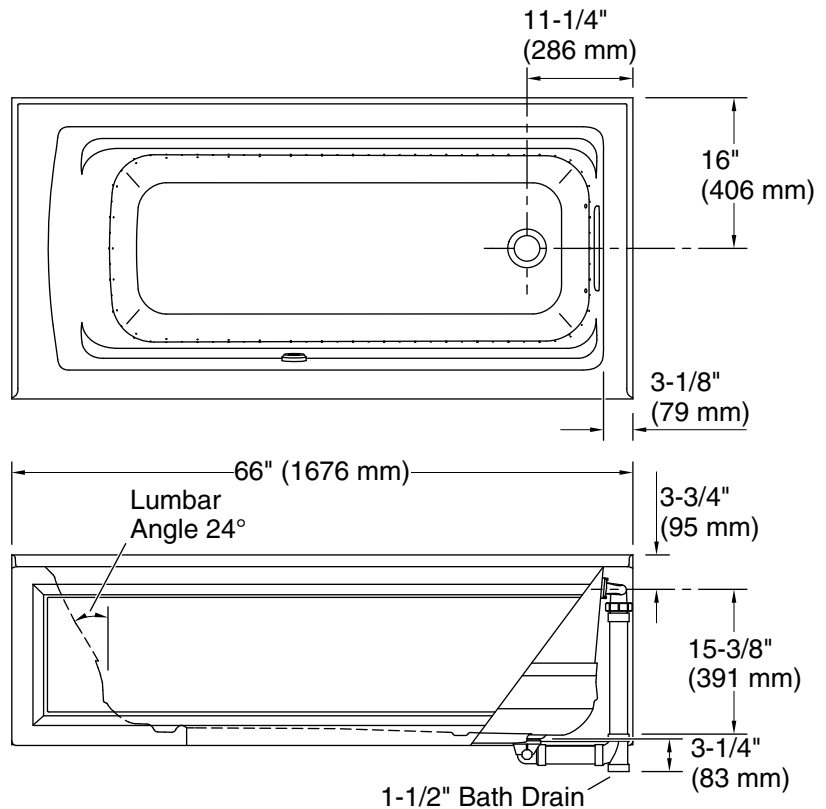
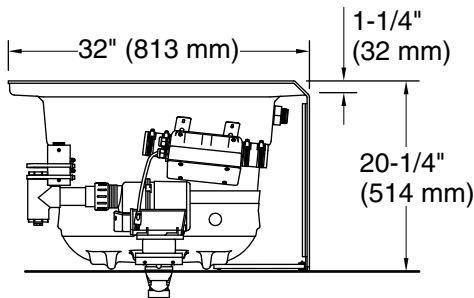

### Required Electrical Service

Two dedicated circuits required, protected with Class A Ground-Fault Circuit-Interrupter (GFCI). Outside North America, this device may be known as a Residual Current Device (RCD).

Blower: 120 V, 15 A, 60 Hz  
Heater: 120 V, 15 A, 60 Hz

### Technical Information

All product dimensions are nominal.

Installation: Three-wall alcove  
Drain location: Right  
Basin area, bottom: 50-3/8" x 19-5/8" (1280 mm x 498 mm)  
Basin area, top: 57-5/16" x 24-1/16" (1456 mm x 611 mm)  
Weight: 120 lbs (54.4 kg)  
Minimum floor load: 47 lbs/ft<sup>2</sup> (229.5 kg/m<sup>2</sup>)  
Water depth: 15-5/16" (389 mm)  
Water capacity: 66 gal (249.8 L)  
Electrical component rating: Blower: 120 V, 10 A, 60 Hz  
Heater: 120 V, 5 A, 60 Hz

### Notes

Measure your actual product for rough-in details.

Install this product according to the installation instructions.

The hot water supply should be 70% of the capacity of the bath or greater. Installations will vary.

Remote blower installation kit is available for relocating the blower. Provide access for servicing the blower.

Do not relocate or alter the PVC tee or coiled flexible tubing connected to the blower. Follow the blower relocation instructions exactly.

ADA compliant when installed to the specific requirements of these regulations.